

5th Annual Ammonia Fuel Conference
Minneapolis, MN, USA, 29-30 September 2008

Properties of laminar premixed hydrogen-added ammonia/air flames



J.H. Lee, J.H. Park and O.C. Kwon*
School of Mechanical Engineering
Sungkyunkwan University
Suwon, Kyunggi-do, Korea



Acknowledgments:

Supported by the Ministry of Environment, Korea



Sungkyunkwan University & ME



■ Sungkyunkwan University:

- ◆ The oldest university in Korea, founded in 1398.
- ◆ One of the leading universities, among the top 5 in Korea.
- ◆ Private university strongly supported by Samsung.

■ School of Mechanical Engineering:

- ◆ Established in 1967.
- ◆ Natural sciences campus.
- ◆ Faculties: 32.
- ◆ Undergraduate students: 727.
- ◆ Graduate students: 135.



Global warming



CO₂ emissions in Korea

- **Korea Metrological Administration report (July 2007): the average amount of CO₂ at the national air monitoring station in Anmyeondo, Chungcheong Province, in 2006 was 388.9 ppm:**
 - ◆ Korea's CO₂ level has been on the rise for seven straight years since 1999 when the amount was 370.2 ppm.
 - ◆ The U.S. Center for Global Development (2007): Korea ranked 10th among the world's greenhouse gas emitters by emitting 185 million tons of such gases annually.
 - ◆ The average temperature in Korea has risen by 1.5 degrees over the last 100 years.

- **The Kyoto Protocol in 1997:**
 - ◆ Under the second phase of the Protocol, Korea may be required to reduce greenhouse gas emissions between 2013 and 2017.
 - ◆ In order to reduce 5% of greenhouse gas emissions in 1995, the estimated cost is 8 billion US dollars.

Hydrogen (H₂)

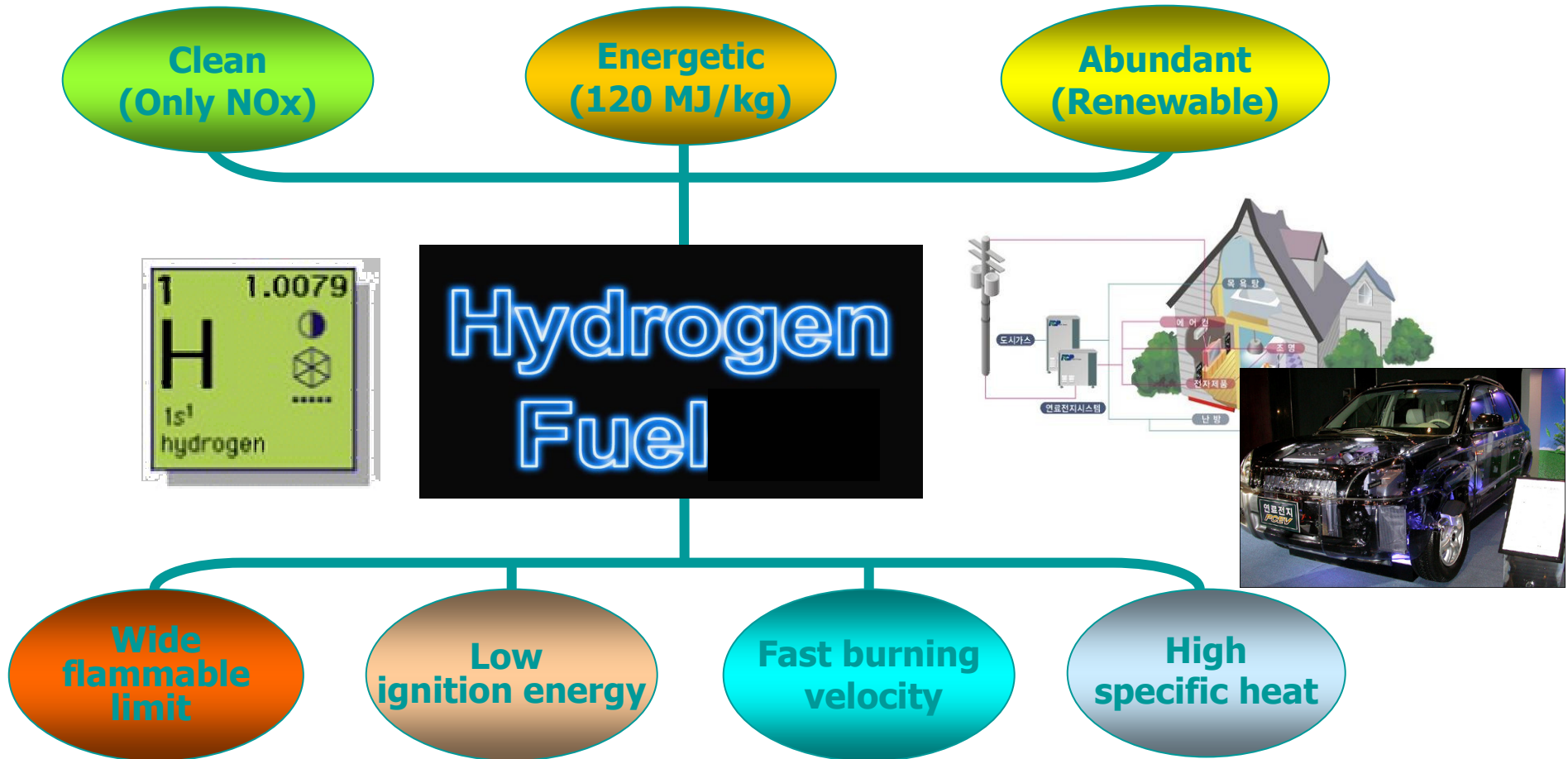

Hydrogen (H₂)

Mass production



Difficulties of transport/storage
Pipelines: infrastructure needed

On-site production

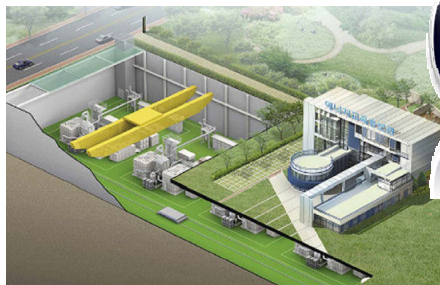

No transport problem if hydrocarbons used
But CO₂/CO emitted

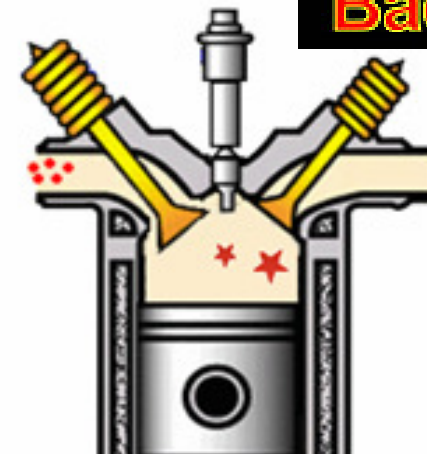

Backfire

Ammonia (NH₃)

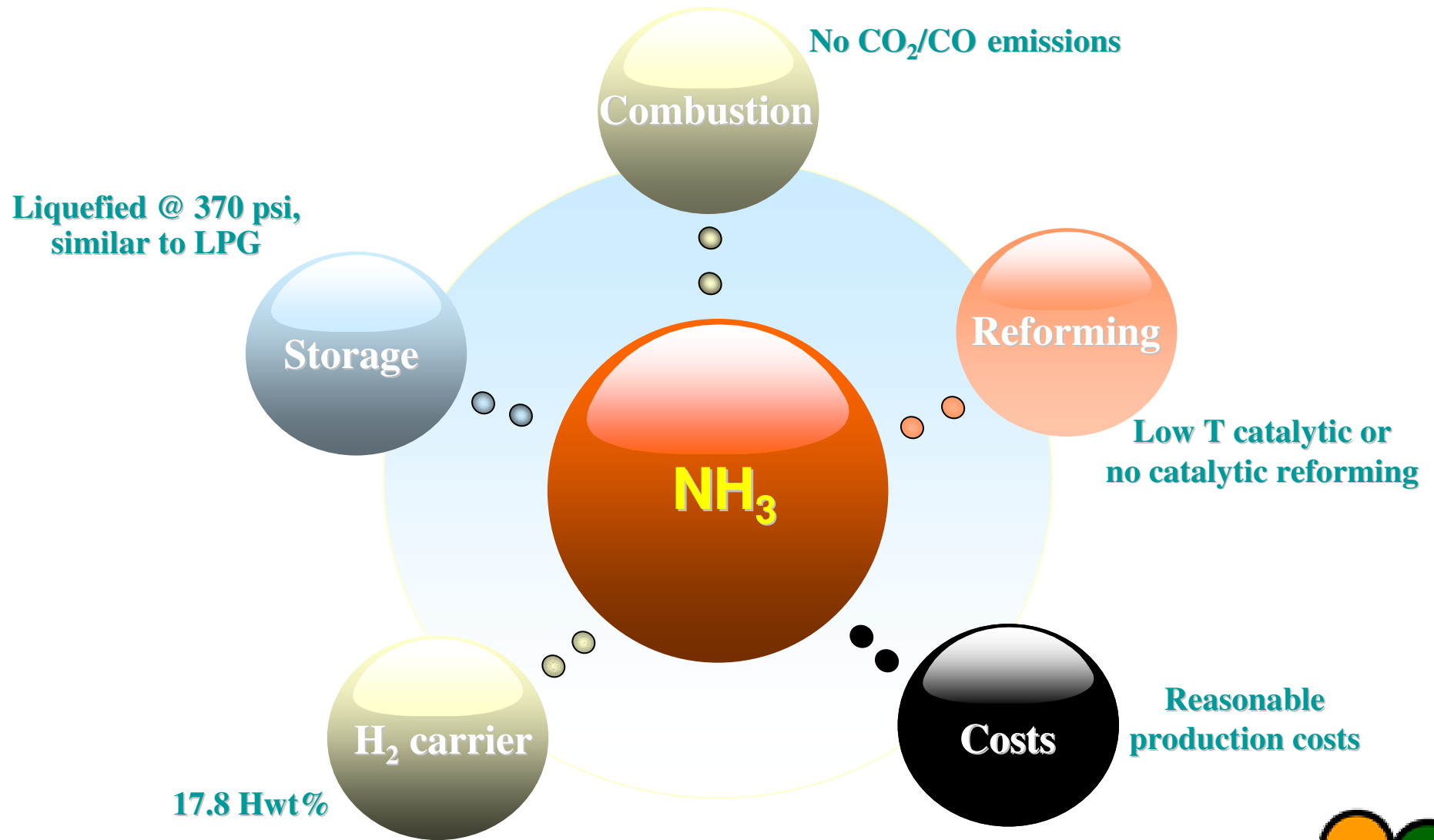

Ammonia in Korea

No earlier works for use of
ammonia as a fuel

- Ammonia has been used for various fields during the last 50 years in Korea:
 - ◆ Fertilizers, refrigerants, catalysts and process chemicals.
 - ◆ Safety issues associated with handling of ammonia resolved.
 - ◆ Related regulations: industrial safety and health regulations and high pressure gas safety regulations.
- Ammonia is cheaper than other fuels; however, 100% imported due to low demand in Korea.

SWOT of use of ammonia as a fuel in Korea

Strengths

- CO/CO₂ free
- High hydrogen density: transport and storage
- Established infrastructure

Weaknesses

- Public concern over toxicity
- 100% imported
- No earlier works for ammonia as a fuel

Opportunities

- Initial stage of research on ammonia as a fuel even in advanced countries
- Increasing public concern on the environment: the Kyoto protocol

Threats

- Price increase of ammonia
- Development first, the environment later policies

Use of ammonia as a fuel: the present project

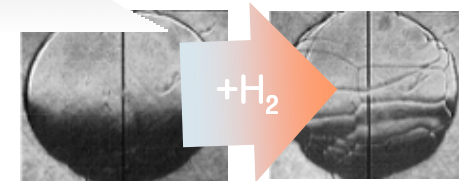
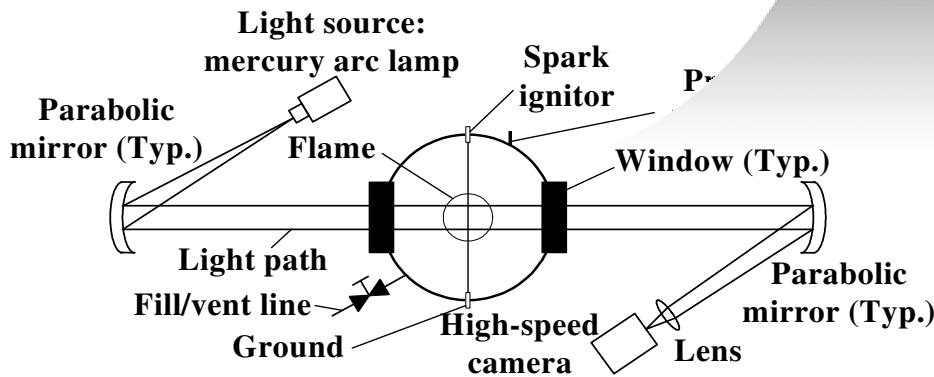
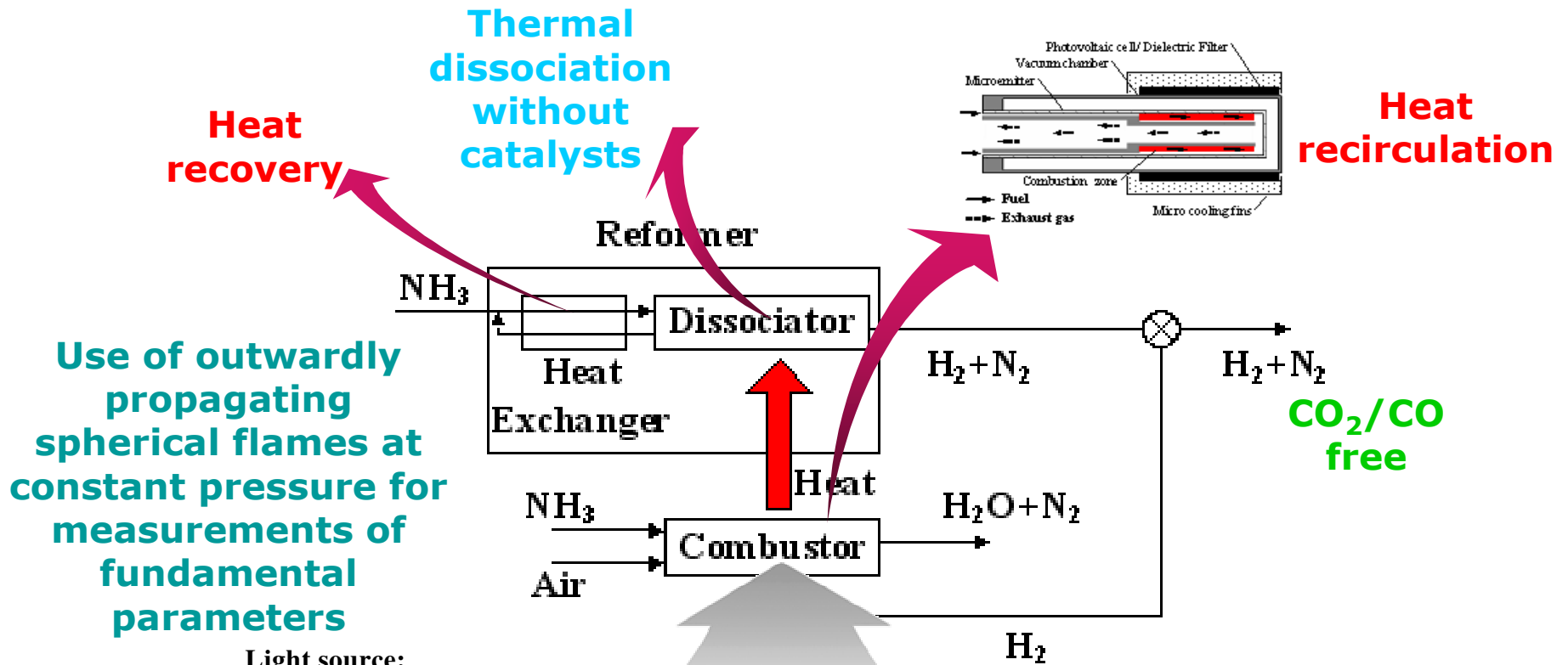

NH₃ combustion

Originalities of the present project

1

Use of ammonia as a fuel

2

Combustion characteristics of ammonia as a fuel

3

Combustion characteristics of hydrogen-added ammonia

4

No catalytic, thermal dissociation of ammonia

5

Use of ammonia for both combustion and reforming

6

Accurate measurements of burning velocities of ammonia

Objective (within 3 years)

Goal

Development of CO₂/CO-free hydrogen generation technology using combustion and reforming of ammonia (miniature/portable size of efficiency of 10-30% and power of 5-30 W)

Research plan

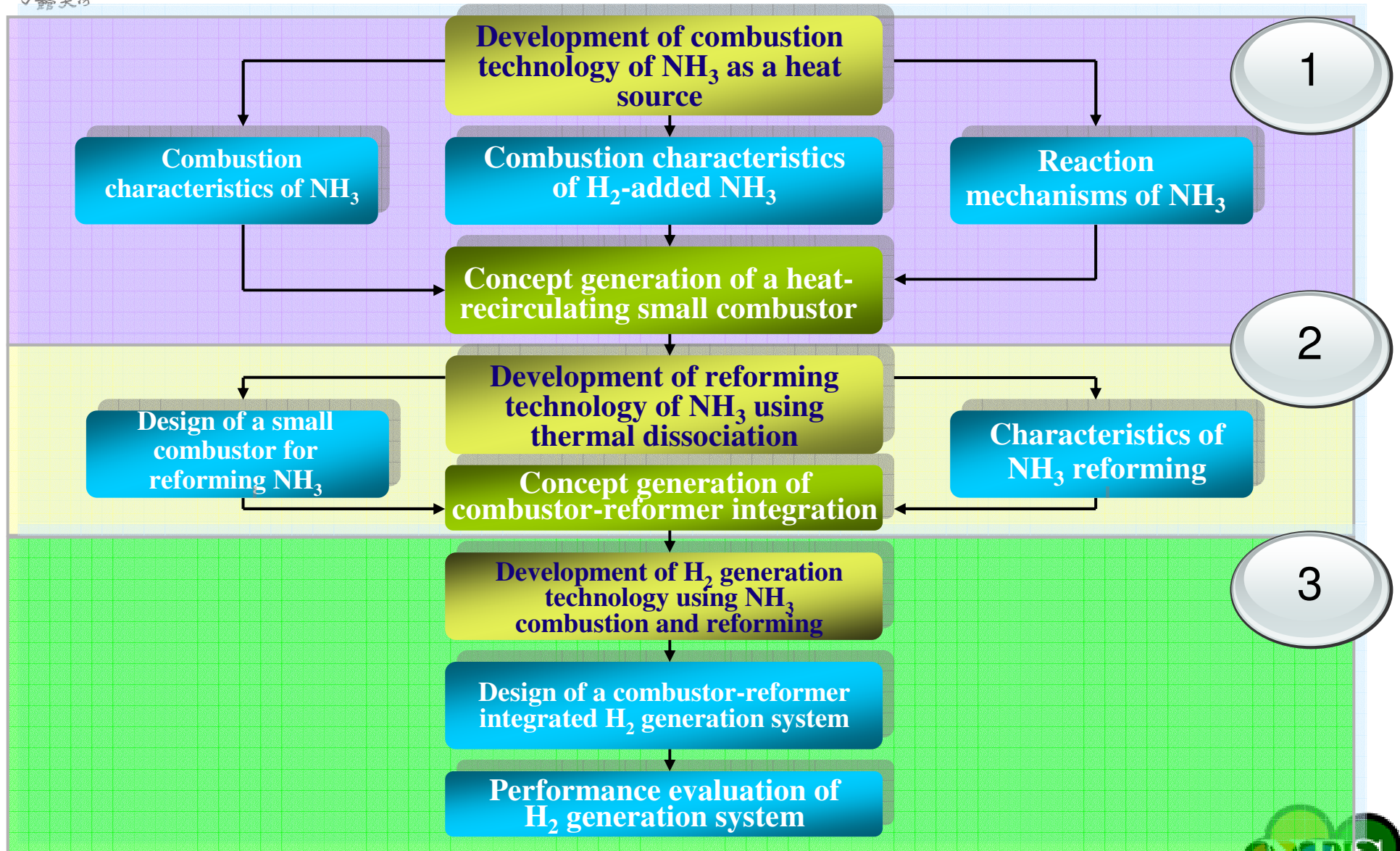

Research Years 1-2

Studies on combustion characteristics of ammonia

Setup of experimental apparatus

Measurements/predictions of combustion characteristics of hydrogen-added ammonia

Understanding of reaction kinetics of ammonia-air via numerical simulations

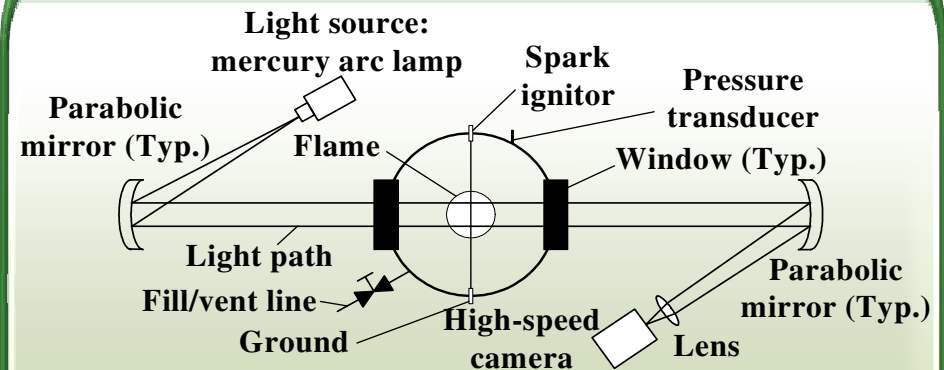

$$S_{L\infty}/S_L = 1 + MaKa$$

$$S_L = (\rho_v/\rho_u) dr_f/dt \quad Ka = K/(S_L/\delta)$$

$$K = (2/r_f) dr_f/dt \quad \delta = D/S_L$$

Research Years 2-3

Studies on reforming characteristics of ammonia

- A study on combustion and heat transfer characteristics in a small combustor via 2/3-D numerical simulations

- Setup of a small heat-recirculating combustor

- Setup of experimental apparatus for ammonia reforming

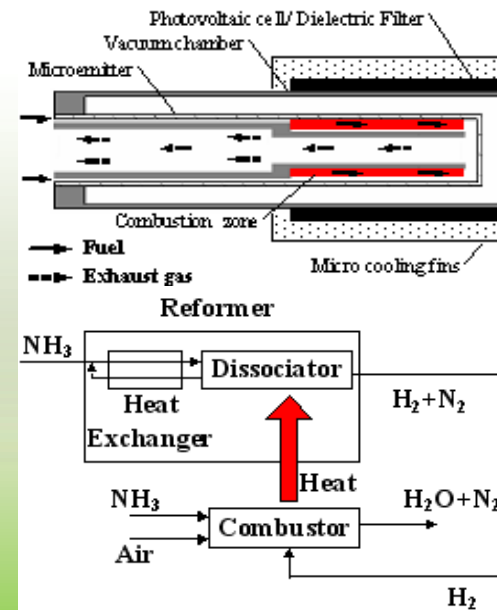

Research Year 3

Studies on hydrogen generation technology using ammonia

- Setup of a combustor-reformer integrated hydrogen generation system

- Performance evaluations of hydrogen generation system

- Demonstration of hydrogen generation technology using ammonia

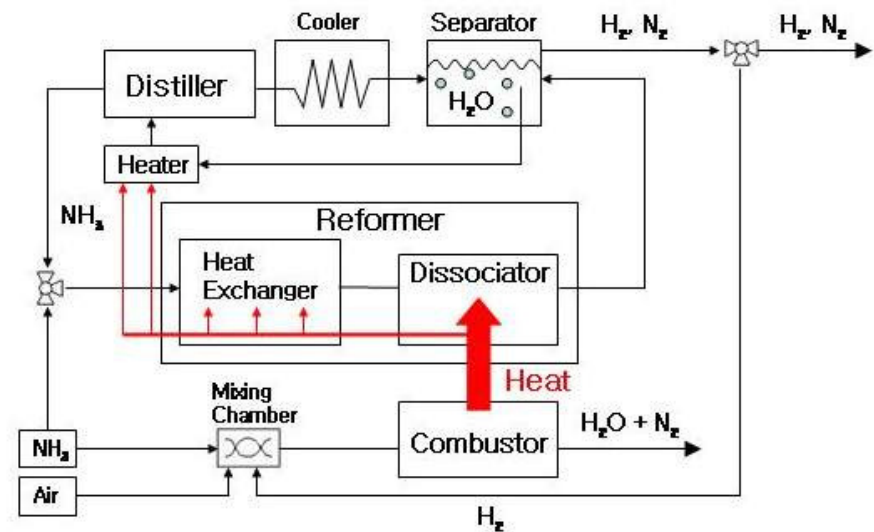

Technological challenges to overcome

■ Combustor:

- ◆ Burning temperature high enough for combustion stability and performance but suppressing NO_x formation
- ◆ Heat losses quenching flames
- ◆ Ignition (delay)
- ◆ Maintenance: no catalyst → heat recirculation concept applied but with NH₃

■ Reformer:

- ◆ Uniform and steady heating: residence time and array
- ◆ Erosive to some materials such as metals

■ Combustor-reformer integrated system:

- ◆ Effective heat transfer between a combustor and a reformer
- ◆ Simple structure with heat recirculation

Expected benefits

Technological

- **Combustion and reforming technologies for using ammonia as a fuel**
- **Technologies for portable H₂ and power generation systems with rapid response time**

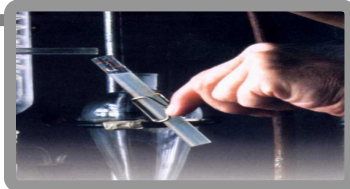

Environmental

- **Reduction of carbon dioxide to prevent global warming**



Economic

- **Replacement of fossil fuels by ammonia, reducing costs to remove greenhouse gases**
- **CO₂ credit price of 3 cents/kg (2005)**



Present status of work

Laminar burning velocities

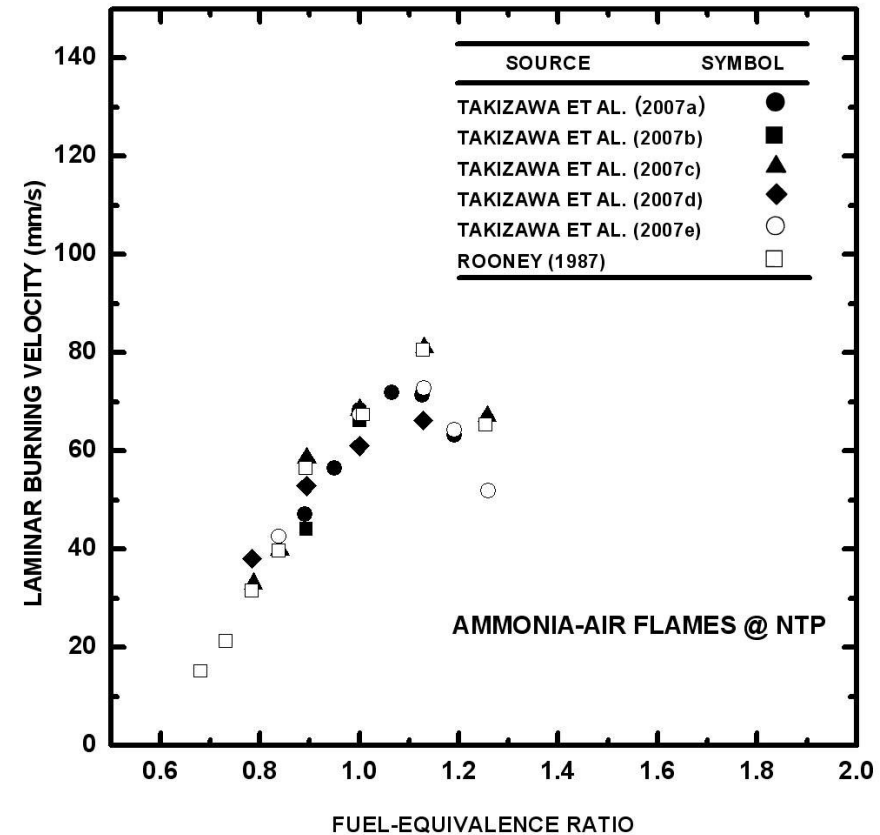
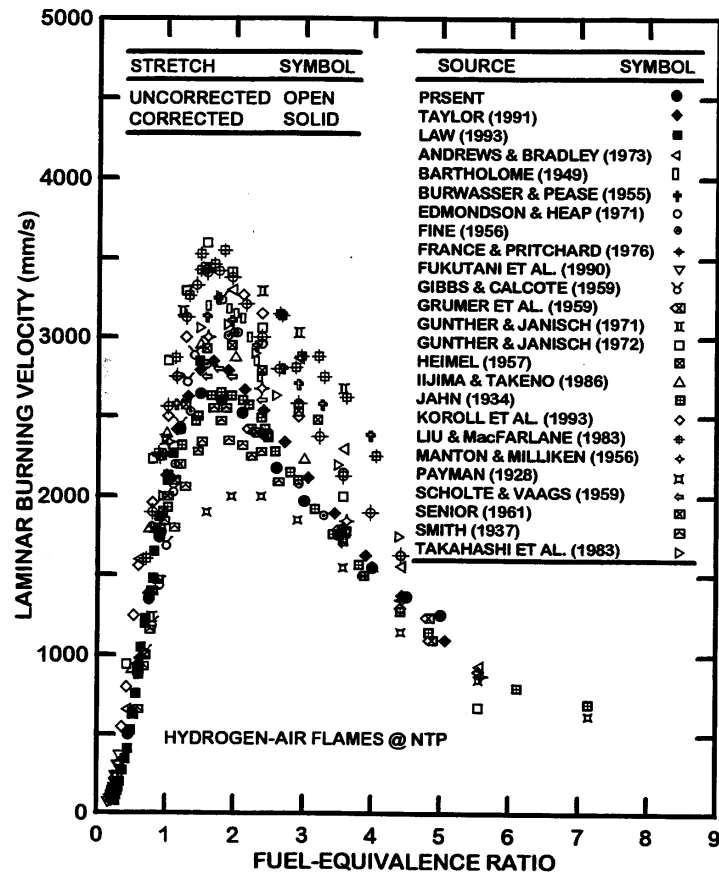

- This provides strong motivation for accurate measurements of laminar burning velocities.

Nonequidiffusion

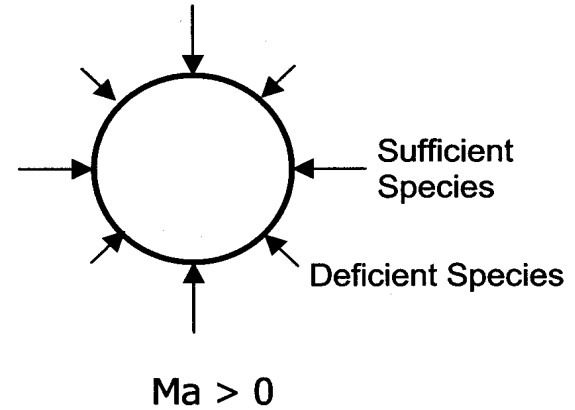
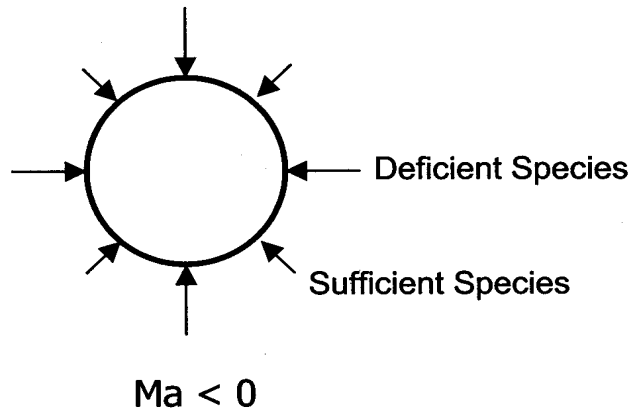

PREFERENTIAL-DIFFUSION

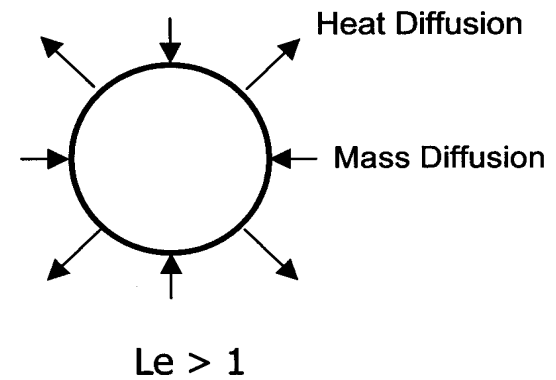
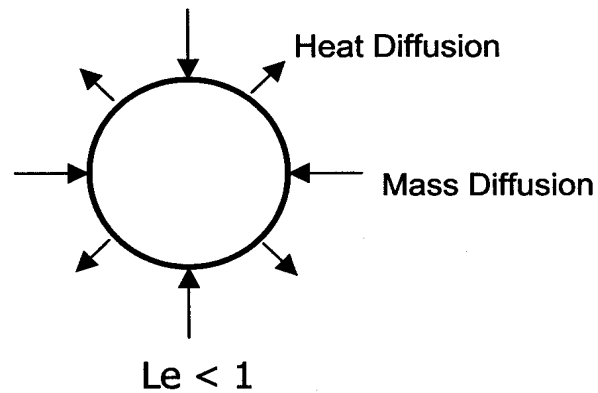

THERMAL-DIFFUSIONAL DIFFUSION

Local-conditions hypothesis

- Laminar burning velocity/stretch interactions are related, following Markstein (1964):

$$S_L = S_{L\infty} - LK \quad (1)$$

- Application of the local-conditions hypothesis of Kwon et al. (1992) then yields:

$$S_{L\infty}/S_L = 1 + Ma Ka \quad (2)$$

where

$$Ka = K \delta_D/S_L, \quad Ma = L/\delta_D, \quad \delta_D = D_u/S_L \quad (3)$$

Flame/stretch response

- Linear response conveniently yields constant Markstein numbers at each reactant condition:

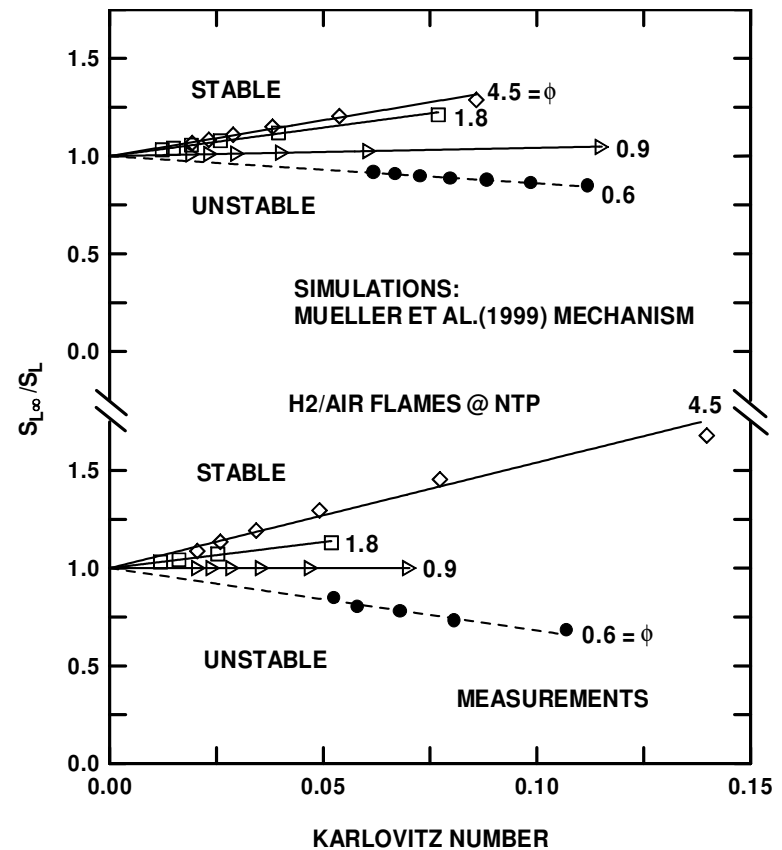
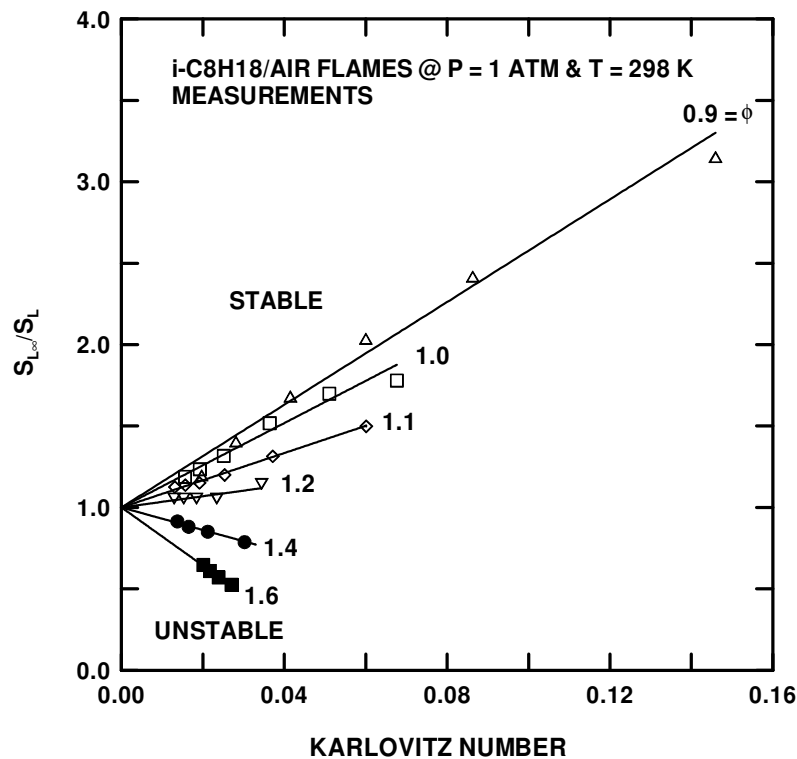

Turbulent flame speed evolution

- Preferential diffusion affects even strongly turbulent premixed flames:

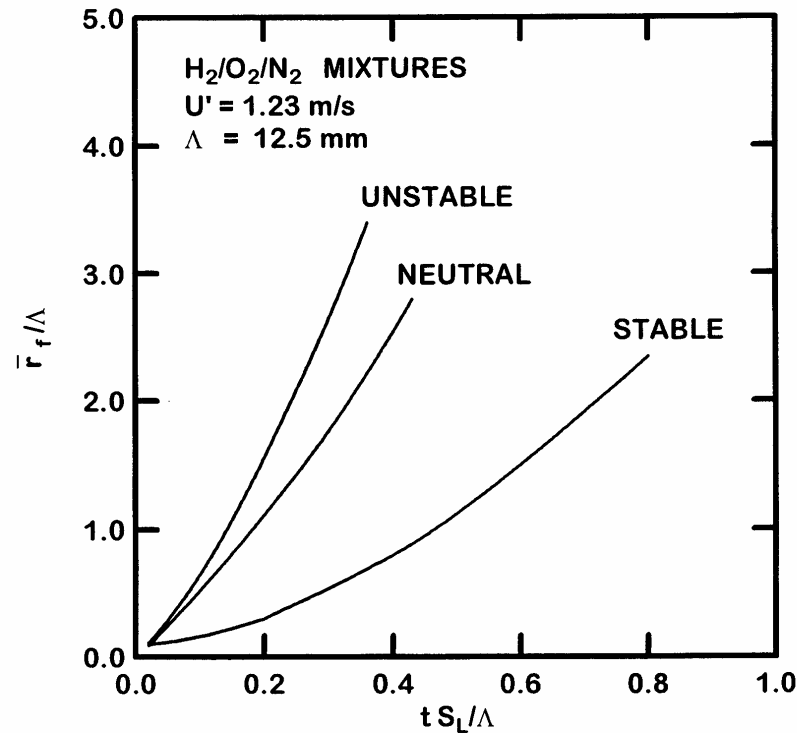

- This provides strong motivation to find laminar flame response to stretch.

Objectives

- **Study effects of H₂-addition on properties of laminar premixed NH₃/air flames:**
 - ◆ **Measure laminar burning velocities for various values of stretch, fuel-equivalence ratios and hydrogen concentrations.**
 - ◆ **Use the measurements to find fundamental unstretched laminar burning velocities and flame response to stretch (Markstein numbers).**
 - ◆ **Use the measurements to evaluate contemporary models of flame structure based on detailed chemical reaction mechanisms.**
- **These fundamental data can be used for designing ammonia-fueled hydrogen generation systems.**

Experimental methods

- Flames are spark ignited at the center of a 320 mm diameter spherical chamber:

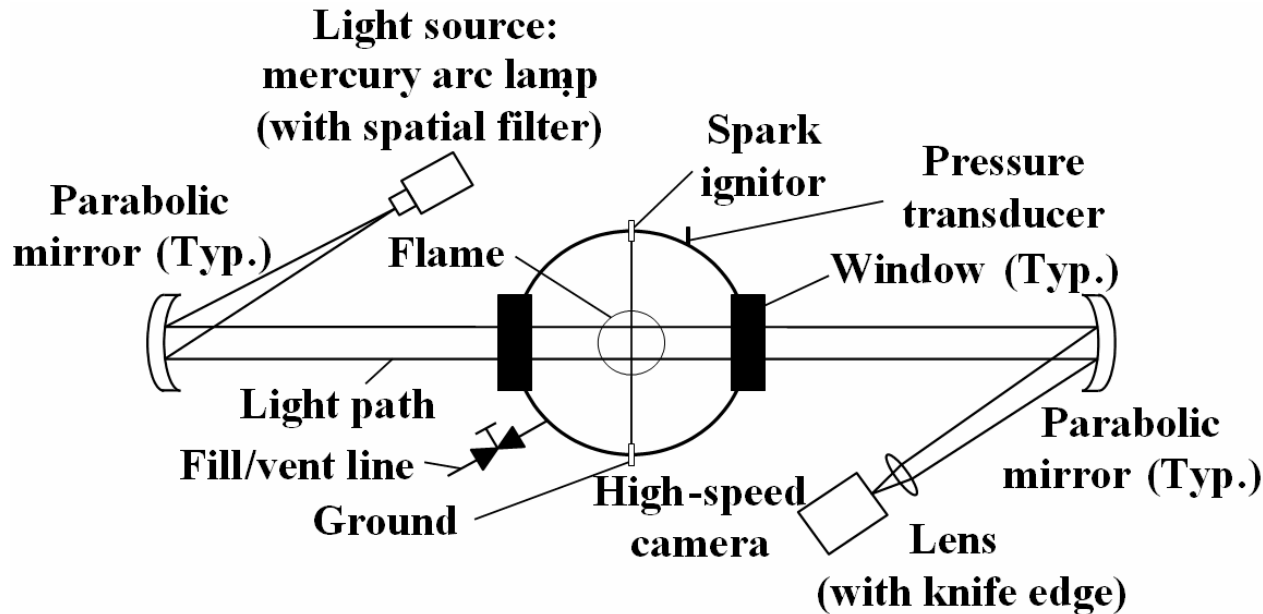

- ◆ Motion picture Schlieren photographs indicate flame stability, rates of propagation and stretch.
- ◆ Measurements are limited to flame radii of 5-30 mm to provide thin, quasi-steady constant-pressure flames.

Data reduction

- Data is reduced where effects of curvature and unsteadiness are small ($\delta_D/r_f \ll 1$) and the following relationships apply:

- ◆ Laminar burning velocity

$$S_L = (\rho_b/\rho_u) dr_f/dt$$

- ◆ Flame stretch

$$K = (2/r_f) dr_f/dt$$

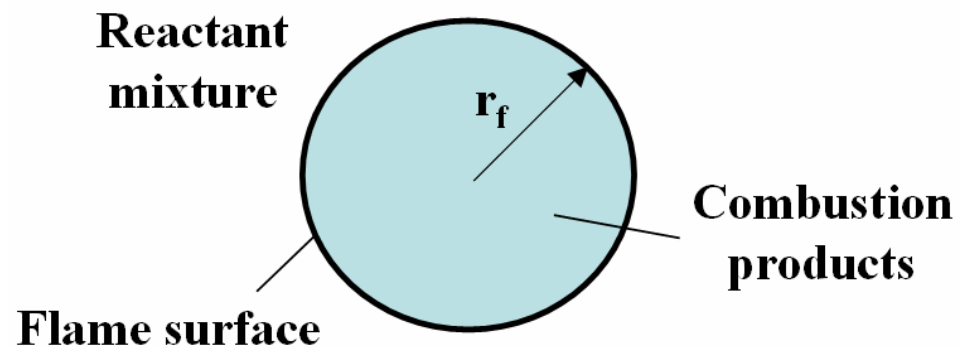

- Results are limited to unwrinkled flames where effects of ignition and buoyancy are small.

Numerical simulations

- **Codes treating variable properties, multicomponent diffusion and thermal diffusion with detailed chemical kinetics are used:**
 - ◆ **PREMIX: steady laminar one-dimensional flame code developed by Kee et al. of Sandia National Laboratories.**
 - ◆ **COSILAB: steady and unsteady laminar one-dimensional flame code developed by Rogg of Ruhr-Universität Bochum.**
- **A detailed N/H/O reaction mechanism of Miller et al. (1989; 73 steps and 19 species) is considered.**

Flame/stretch response: NH₃/H₂/air flames

- Linear response conveniently yields constant Markstein numbers at each reaction condition (predicted results only):

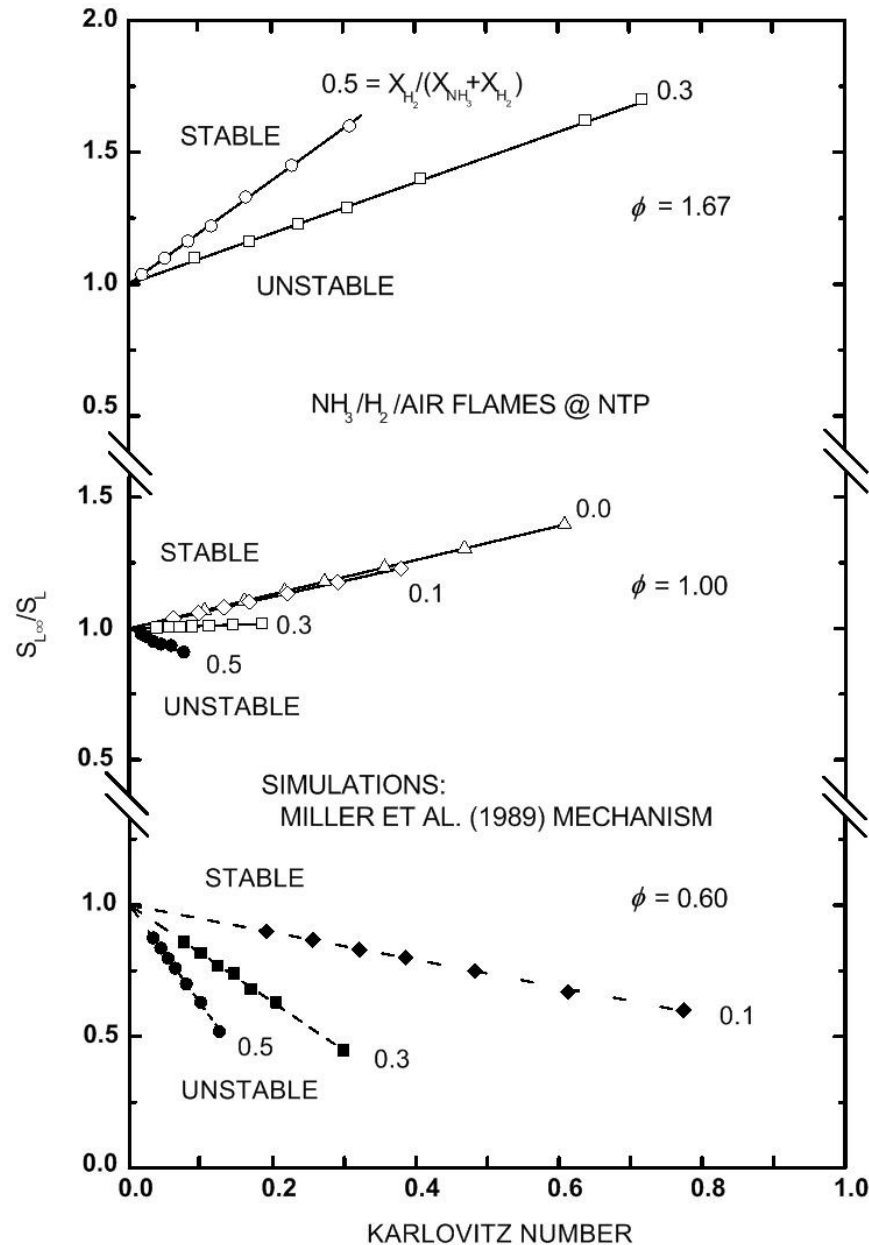

Unstretched laminar burning velocities

- Hydrogen functions by increasing light radical concentrations (predicted results only):

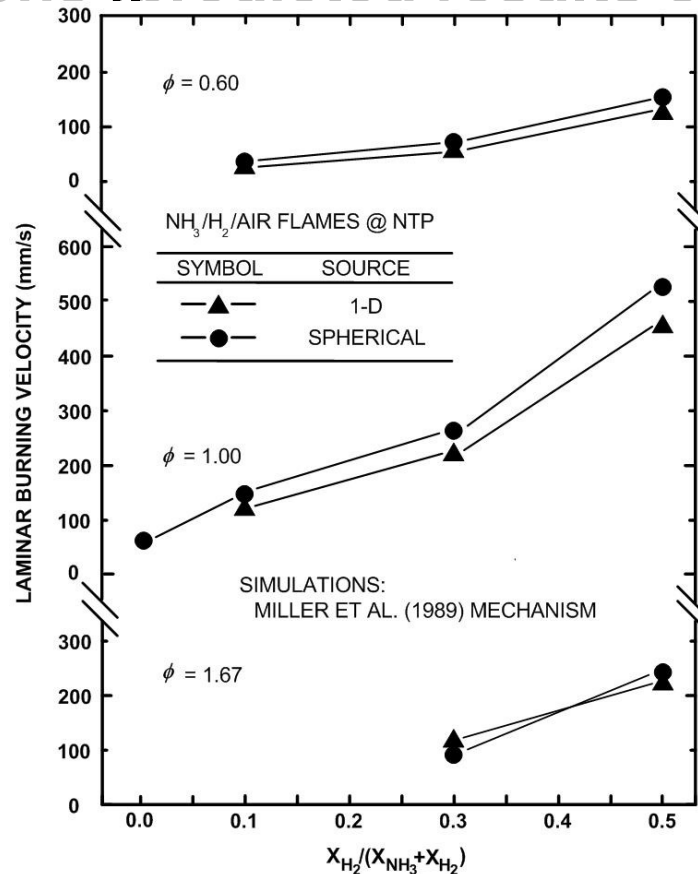

- Laminar burning velocities increase as hydrogen concentrations increase due to enhanced light radical concentrations.

Markstein numbers

- Increased hydrogen concentrations enhance unstable nonequidiffusion/stretch interactions for fuel-lean and stoichiometric conditions (predicted results only):

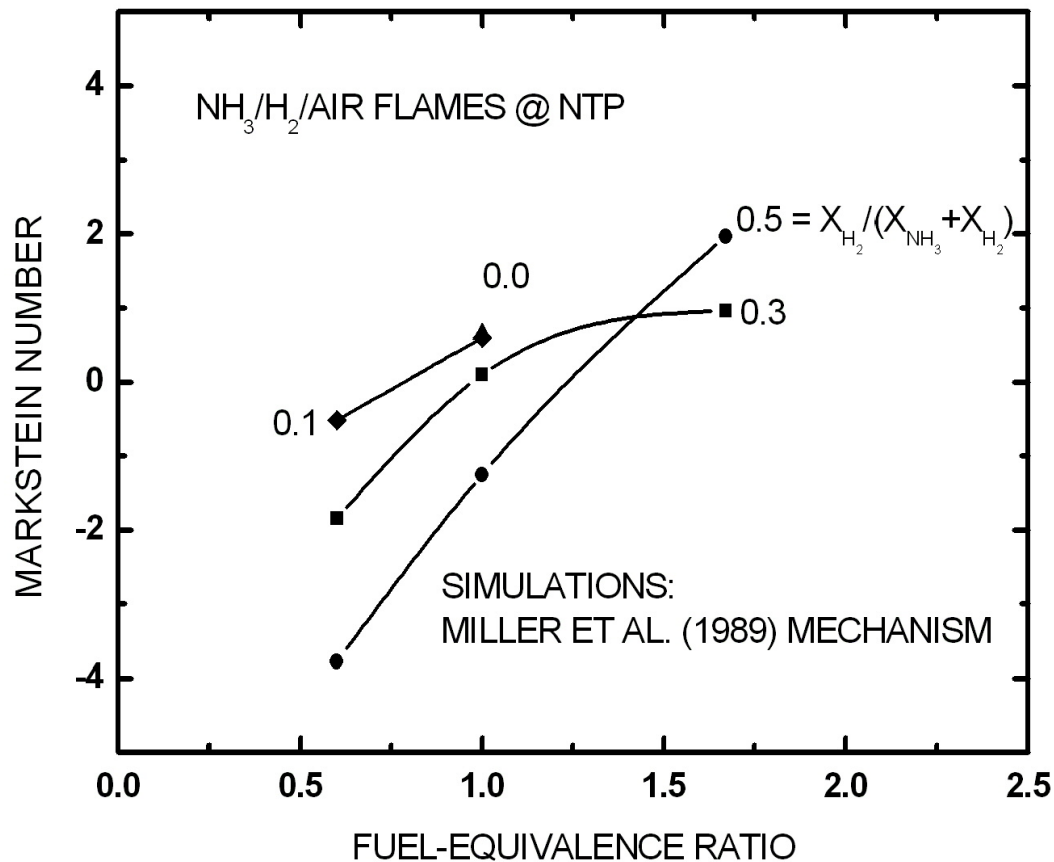

Predicted flame structure

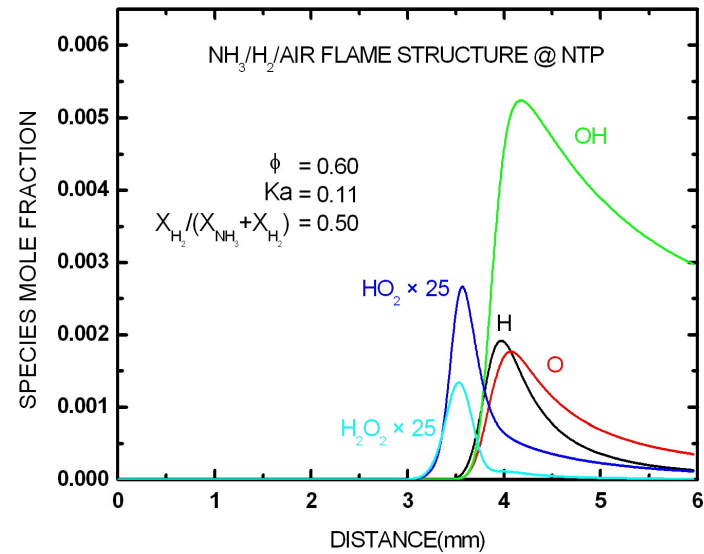
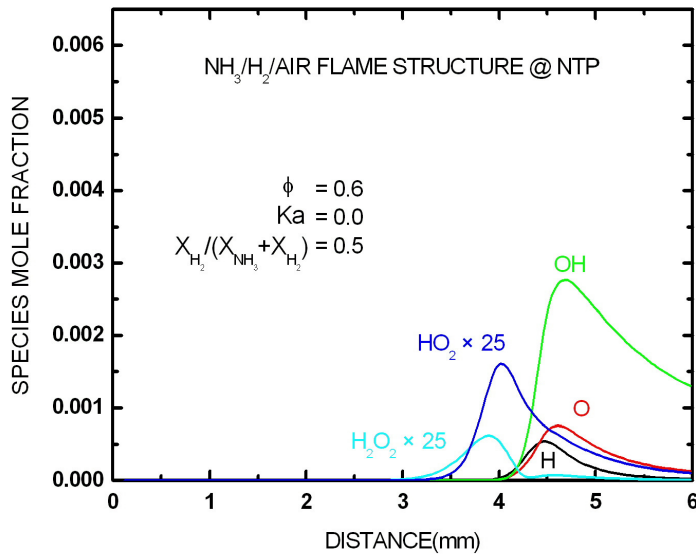
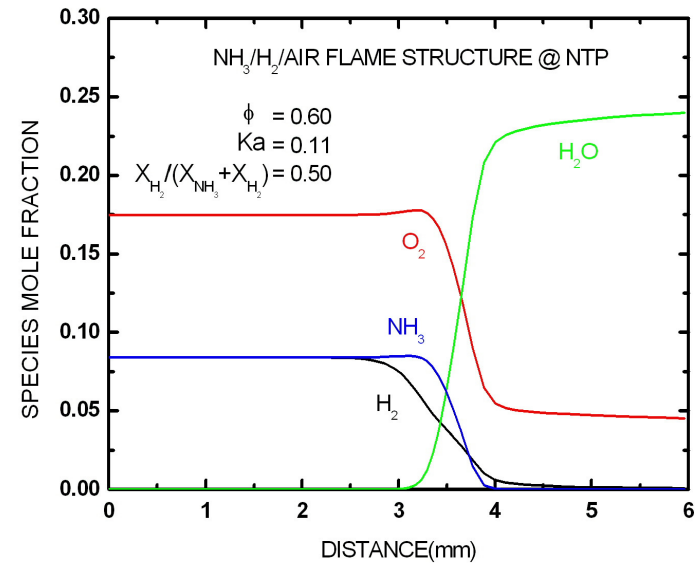
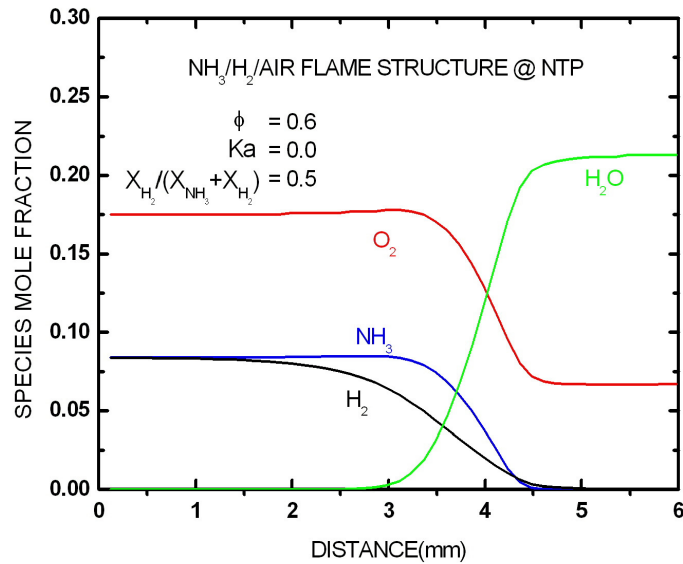

Concluding remarks

- The local-conditions hypothesis yielded a simple correlation of flame/stretch interactions with Ma independent of Ka for moderate and even high levels of stretch.
- Flame/stretch interactions were substantial for hydrogen-added ammonia/air flames with laminar burning velocities varying in range 0.4-1.7 the unstretched value for $Ka < 0.8$.
- Hydrogen acts to increase light radical concentrations and thus laminar burning velocities, which is desirable for intensifying burning of pure ammonia.
- Once combustion characteristics of ammonia are investigated, a heat-recirculating ammonia-fueled combustor will be designed.