

Developing Fuel Injection Strategies for Using Ammonia in Direct Injection Diesel Engines

Matthias Veltman

Dr. Song-Charng Kong

Department of Mechanical Engineering

Iowa State University

Acknowledgements:

Iowa Energy Center (Norman Olson, Kevin Nordmeyer)

Robert Bosch LLC (Thomas Stach)

National Instruments

- Background information
- Previous project
- Update on current test activity

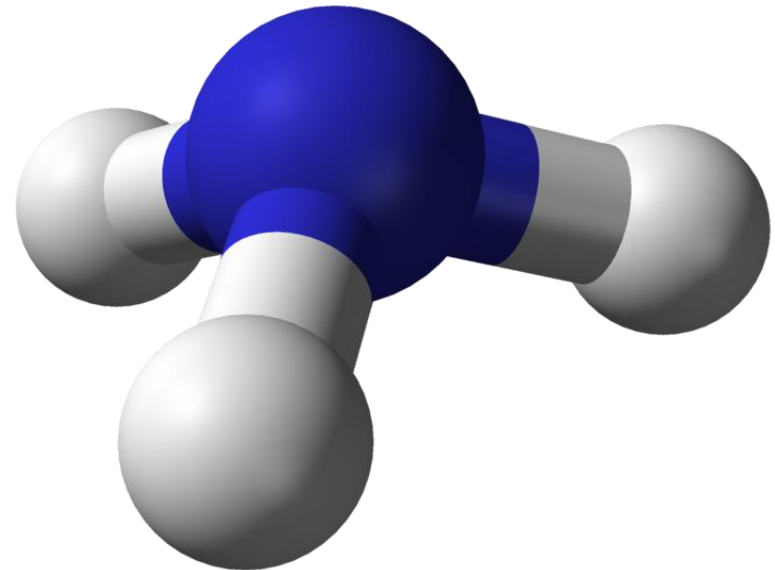

- **Motivation**

- Ammonia (NH_3) combustion does not generate CO_2
- Hydrogen carrier, renewable, etc.

- **Challenges**

- Ammonia is very difficult to ignite
 - Octane number ~ 130
 - Autoignition T ~ 651 °C (gasoline: 440 °C; diesel: 225 °C)
 - High latent heat of vaporization ~ 1370 kJ/kg (gasoline: 380 kJ/kg; diesel: 375 kJ/kg)
 - Narrow ignition limits ~ 16 – 27 %-v in air
 - High vapor pressure ~ 10 bar @ ambient temperature
- Ammonia flame temperature is lower than diesel flame T
- Erosive to some materials
- Ammonia emissions can be harmful
- Potential high NO_x emissions due to fuel-bound nitrogen

Fuel	Formula	Storage Temp. [°C]	Storage Pressure [kPa]	Density [kg/m ³]	Lower Heating Value [MJ/kg]	Stoichiometric Air/Fuel Ratio by Weight	Energy Content [MJ/kg-stoichiometric mixture]	Autoignition Temp. [°C]	Cetane Rating
Ethanol	C ₂ H ₅ OH	25	101.3	790	27	8.95	2.70	423	-
Gasoline	C ₇ H ₁₇	25	101.3	700	42.5	15.29	2.58	370	-
Hydrogen (gas)	H ₂	25	24,821	17.5	120	34.32	3.40	571	-
Hydrogen (liquid)	H ₂	-253	102	71	120	34.32	3.40	571	-
Diesel	C _{14.4} H _{24.9}	25	101.3	850	45	14.32	2.77	254	40-55
Methanol	CH ₃ OH	25	101.3	780	19.5	6.44	2.69	464	5
Dimethyl Ether	CH ₃ OCH ₃	25	1030	660	28.4	8.95	2.85	350	55-60
Ammonia	NH ₃	25	1030	600	18.8	6.05	2.64	651	-

- Although ammonia has a fairly low heating value – its energy content per unit mass of stoichiometric mixture is comparable to conventional gasoline and diesel fuels.
- Ammonia has superior energy-density over hydrogen.

- Dual fueling of ammonia and diesel fuel
 - Introduce ammonia_(g) to the intake manifold
 - Create premixed ammonia/air mixture in the cylinder
 - Inject diesel (or biodiesel) to initiate combustion
 - No modifications to existing diesel injection system

Ammonia fuel line

Induction point



- Obtained stable engine power output
- Low CO₂ emissions
- Reasonable fuel economy between 40~60% diesel fueling
- Ammonia combustion efficiency ~ 95%

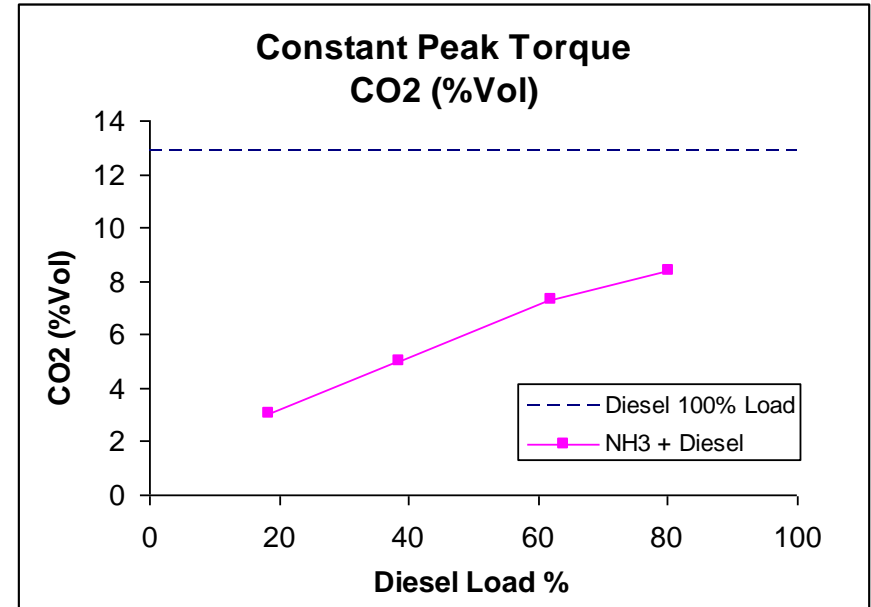
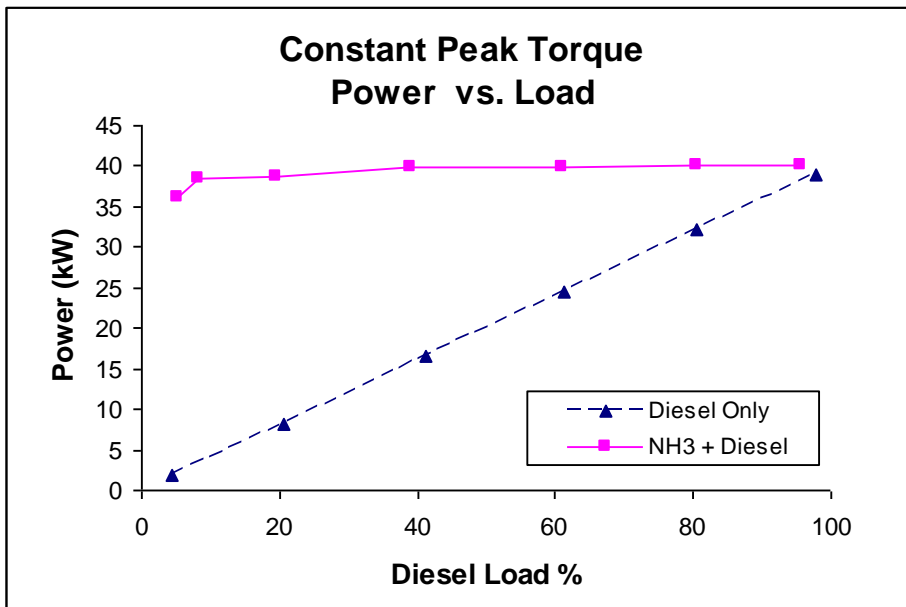

- NO emissions are comparable or less than engine operation on regular diesel
- Overall high ammonia emissions – some might also be caused by positive valve overlap in combination with boosted engine operation.

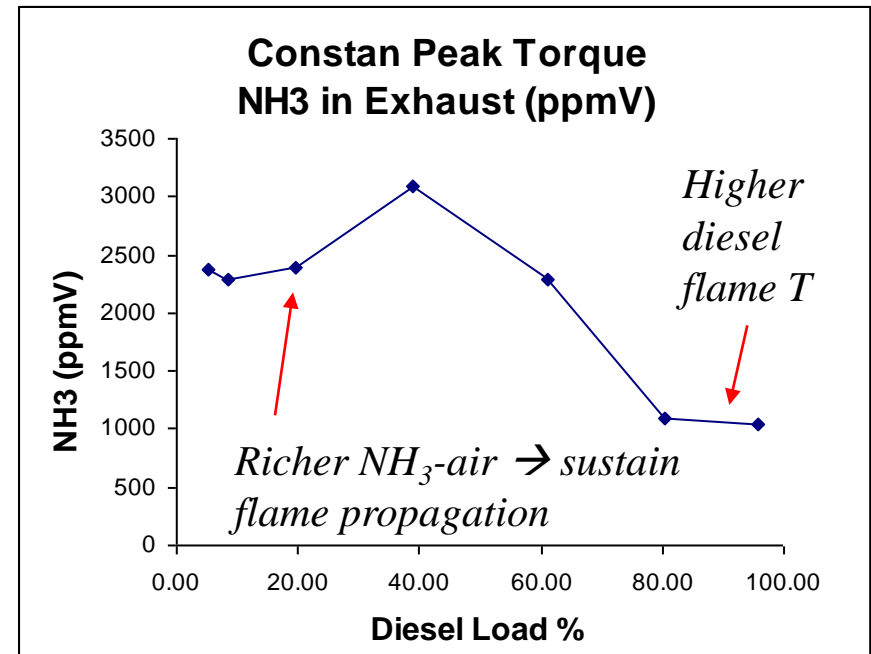
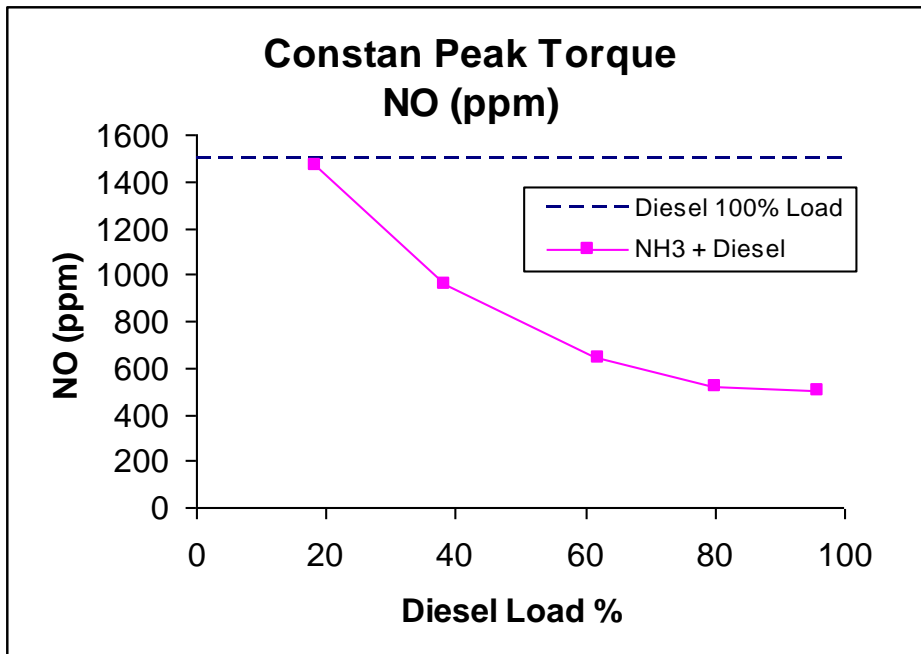

- Ammonia and a secondary fuel are mixed in a separate facility (no longer part of vehicle)

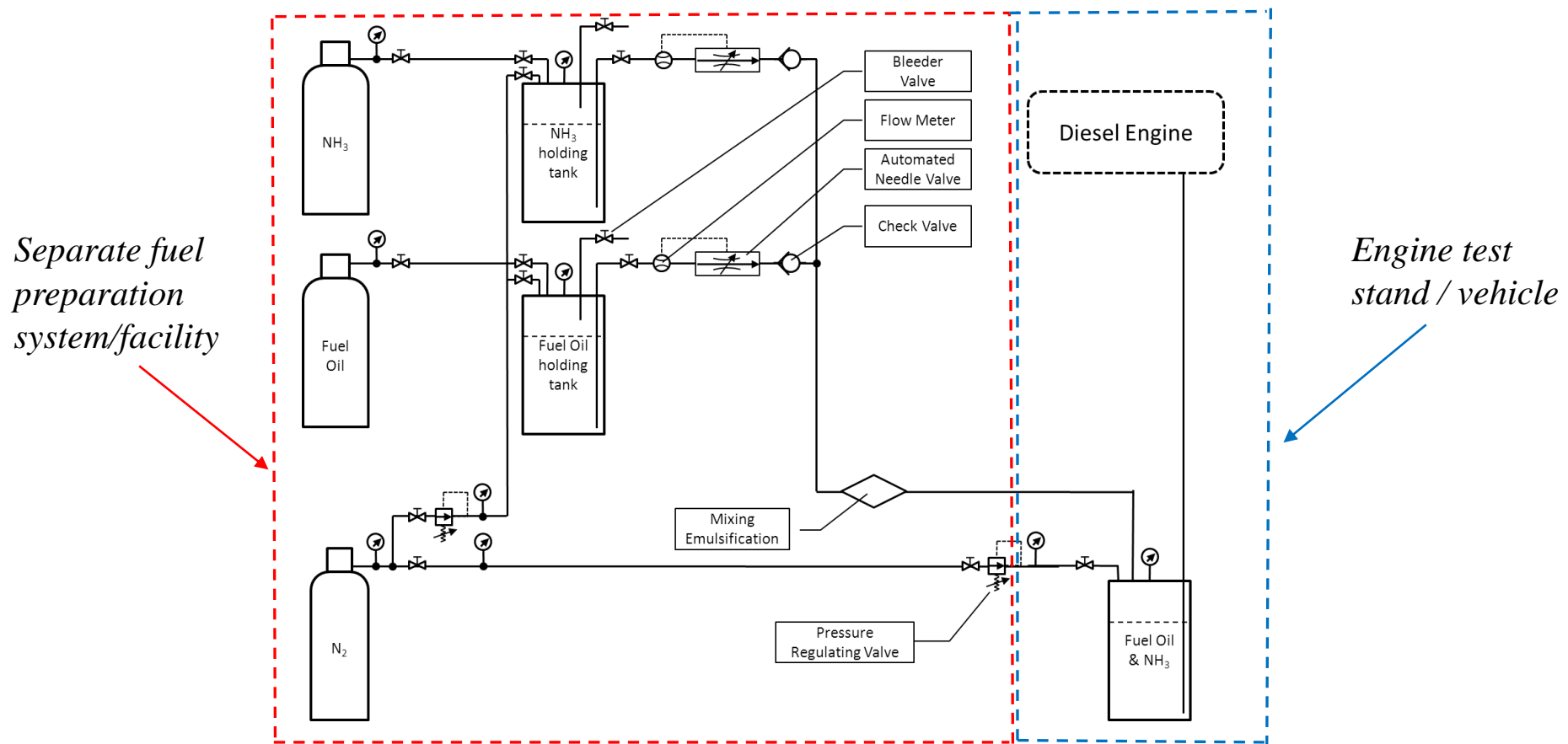

- Yanmar single cylinder direct injection diesel engine
- Custom fuel injection system

Engine Model	Yanmar L70V
Engine Type	Air Cooled, Four Stroke, Compression Ignition
Combustion Type	Direct Injection
Cylinder Arrangement	Vertical
Type of Aspiration	Natural Aspiration
Bore x Stroke (mm)	78 x 67
Compression Ratio	20:1
Total Displacement (cm ³)	320
Valves per Cylinder (Int./Exh.)	(1/1)
Rated Speed (rpm)	3600
Rated Power (kW)	4.3
Brake Specific Fuel Consumption at rated Output ($g_{\text{Diesel}}/\text{kWh}$)	268
Balancing System	Single, Counter-Rotating, Balancer Shaft
Type of Injection System	Electronically controlled
Injection Pump	External Pump
Injector Nozzle	Custom

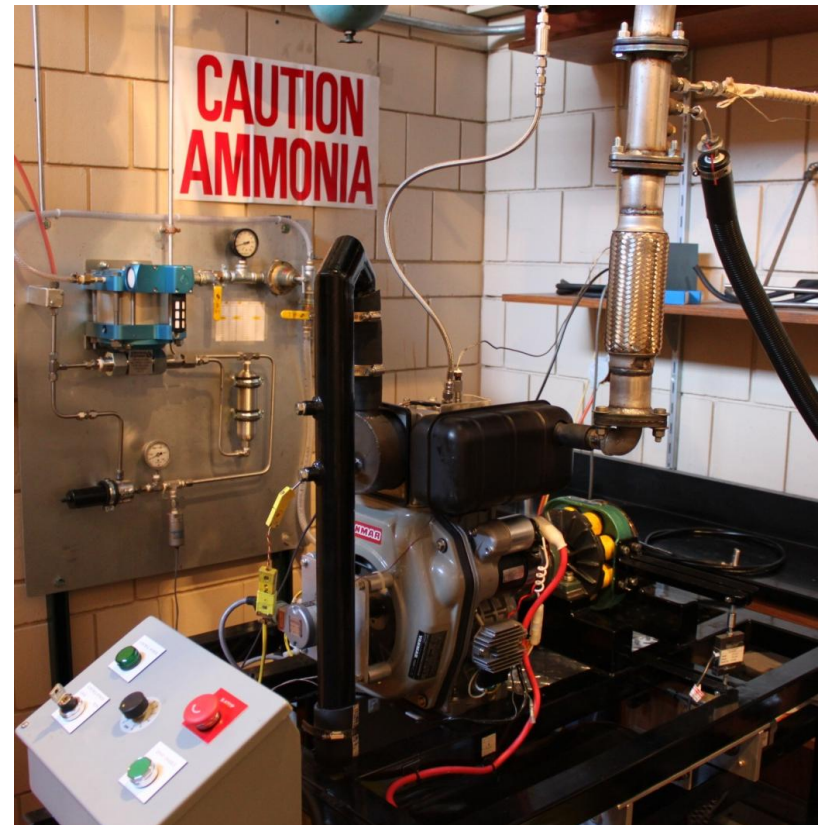

Comparison of boosted vs. non-boosted Injector Operation

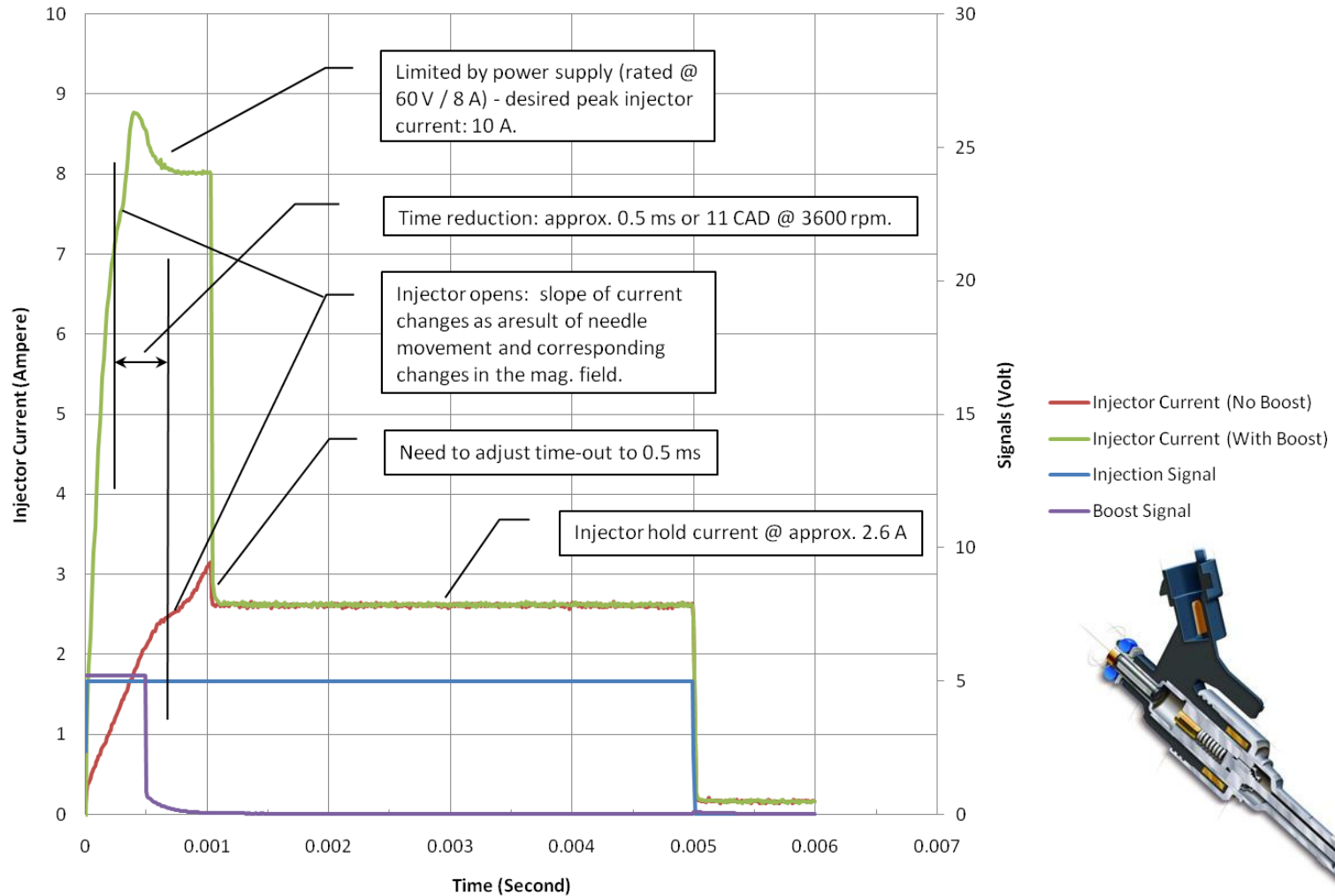

- A year ago ...



- Today...



- Electronically controlled common rail direct fuel injection
 - Multiple Injections per combustion cycle
- Bosch fuel injector:
 - Modified gasoline direct injection fuel injector
 - All wetted parts are made from stainless steel
 - Injection pressures of up to 200 bar
- Rail pump:
 - External pump
 - High pressure, air-operated piston pump
- Engine Control Unit
 - Hardware: National Instruments CompactRIO system
 - Injector driver: Iowa State University
 - Software: Iowa State University
- Emissions Analytics
 - Horiba Mexa 7100DEGR (CO₂, CO, O₂, HC)
 - Horiba 1170NX (NO_x, NH₃)
 - AVL Variable Sampling Smoke Meter (PM)



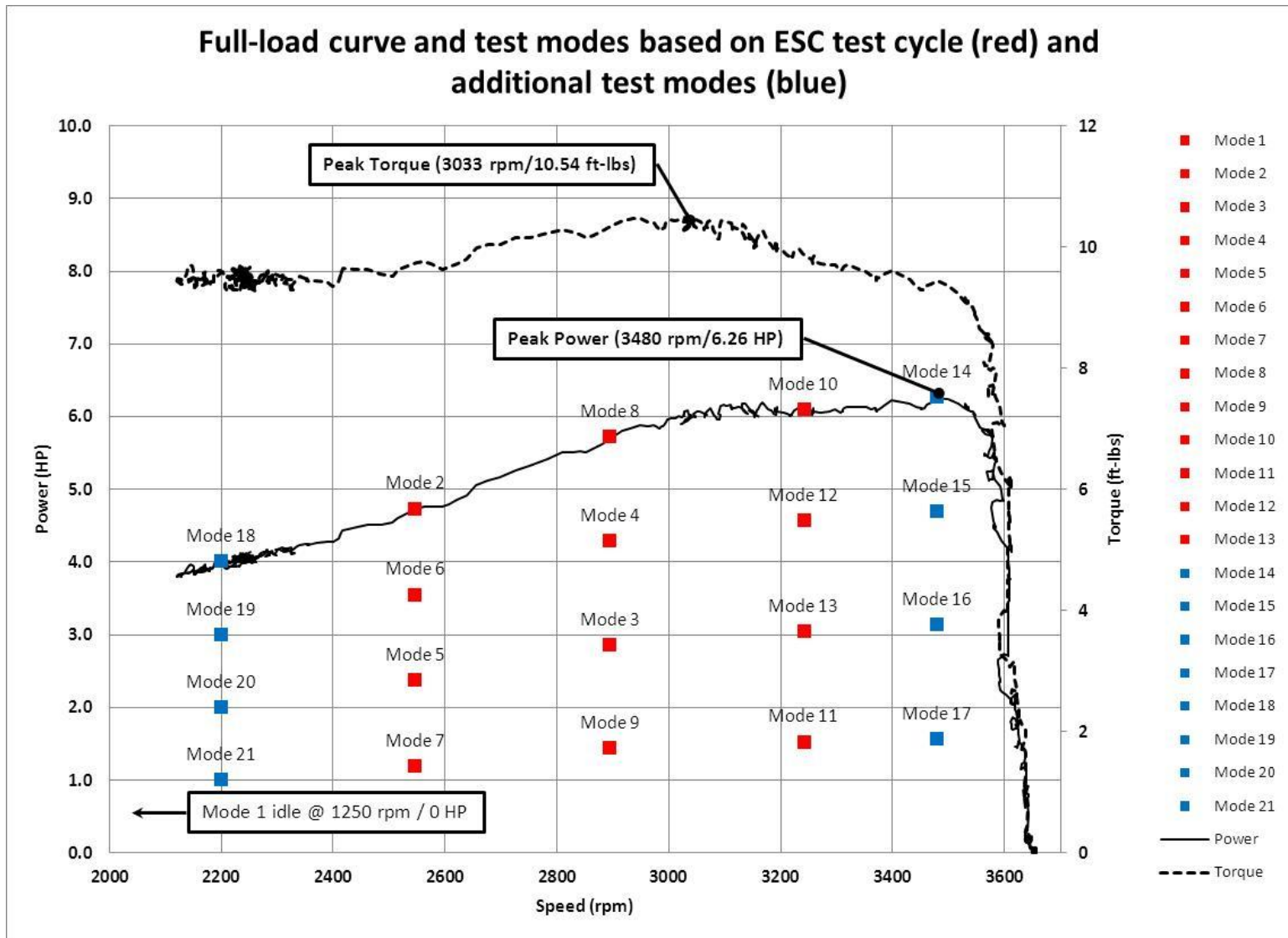

- Mode 1
 - Mode 2
 - Mode 3
 - Mode 4
 - Mode 5
 - Mode 6
 - Mode 7
 - Mode 8
 - Mode 9
 - Mode 10
 - Mode 11
 - Mode 12
 - Mode 13
 - Mode 14
 - Mode 15
 - Mode 16
 - Mode 17
 - Mode 18
 - Mode 19
 - Mode 20
 - Mode 21
- Power
 - - - Torque

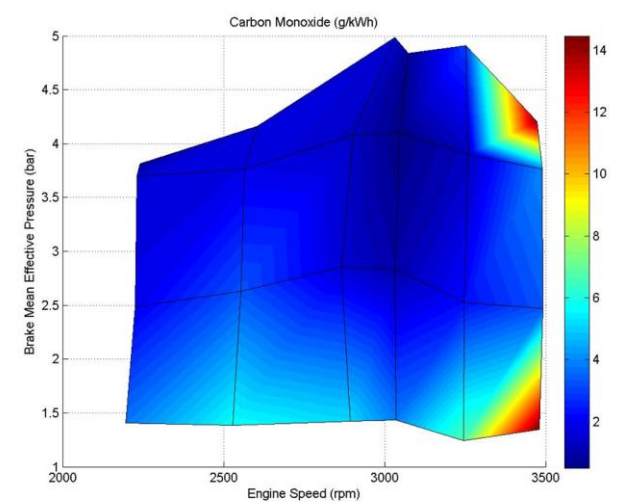
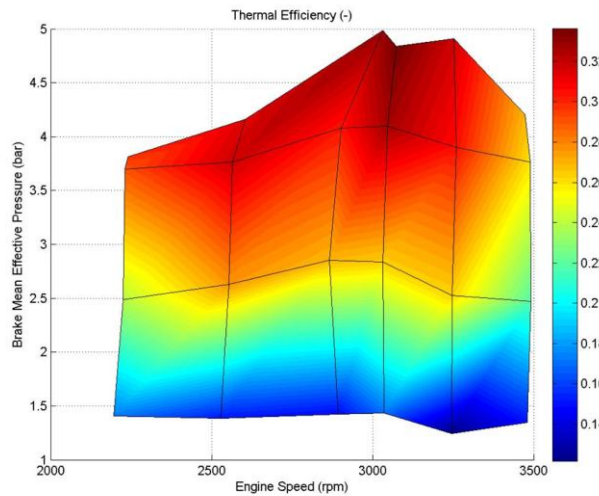
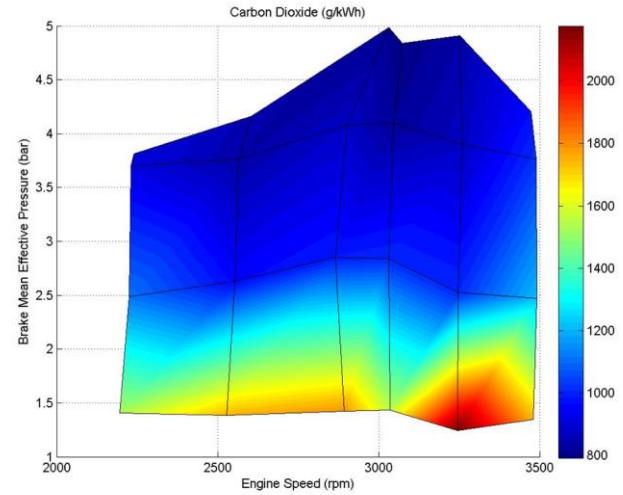
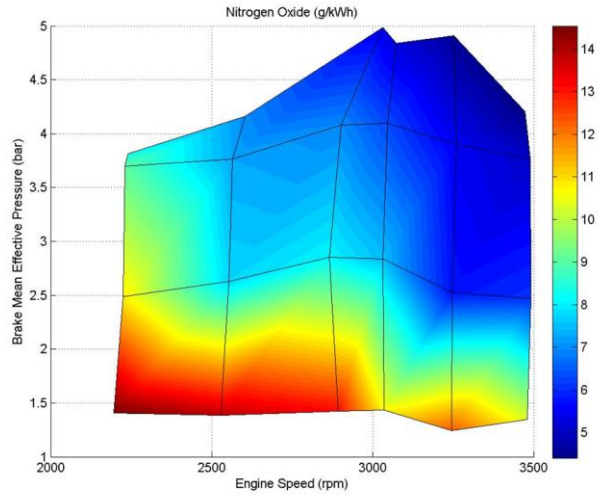

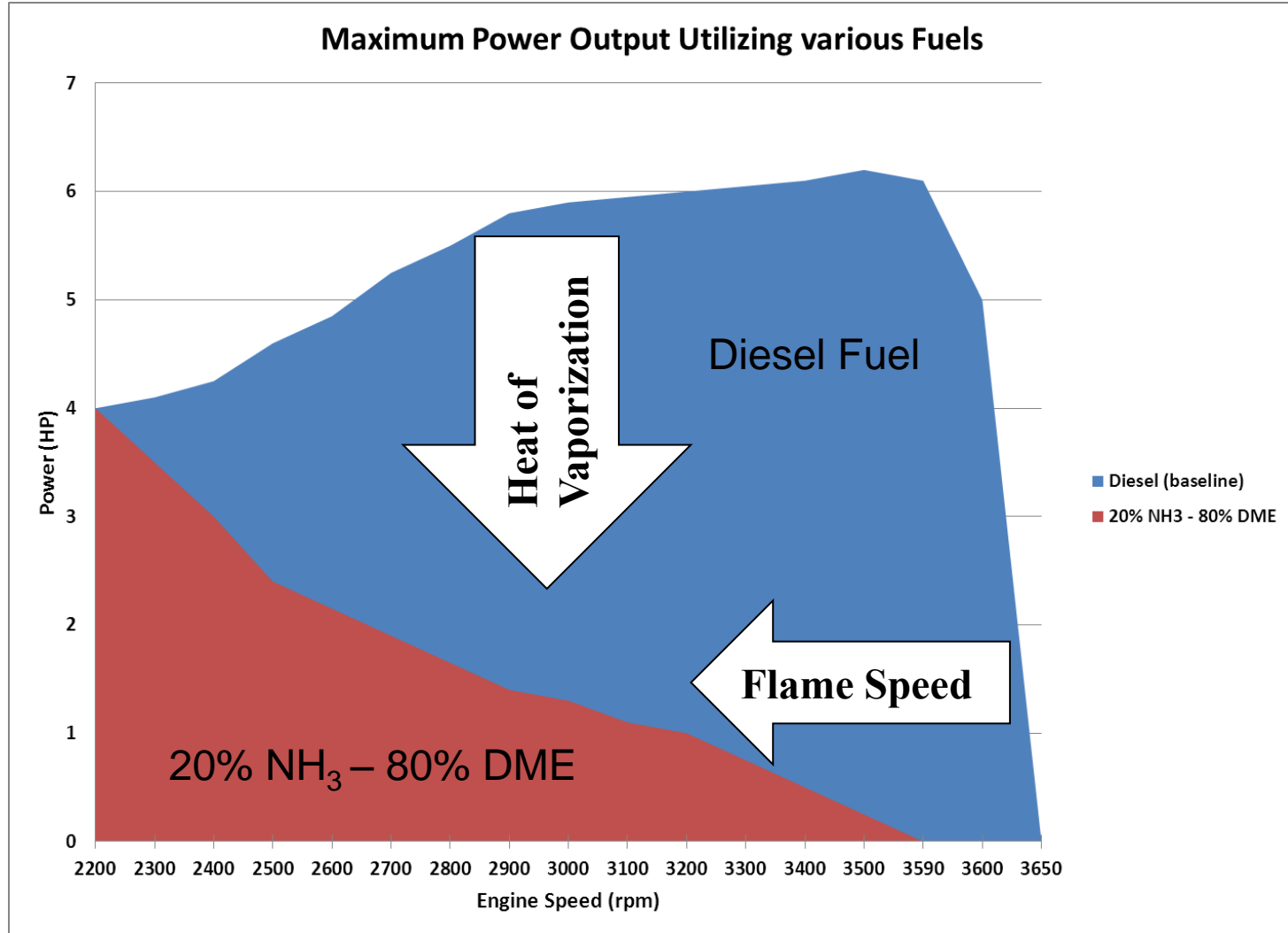

- Challenges:
 - Reduce heat loss to vaporization of fuel \Leftrightarrow multiple injections
 - Increase flame speed \Leftrightarrow increase combustion temperature \Leftrightarrow pre-heat intake air
 - Mixing of fuel and air \Leftrightarrow new injectors with improved spray pattern
- Targets:
 - Near zero ammonia concentration in exhaust (10 ppm or less)
 - Thermal efficiency comparable to conventional diesel engine ($\geq 40\%$)
 - Low NO_x emissions (≤ 7.5 g/kWh – Tier 4)
 - High ammonia content in fuel mixture ($\geq 90\%$)
 - Useful engine map comparable to that of base engine

- Thank you for your attention !
 - Questions?
 - Contact Information:
Matthias Veltman
mveltman@iastate.edu